

# TRENCHER ATTACHMENTS

## Features of our Trenchers

### HIGH QUALITY MOTOR AND GEARBOX

Using only the highest quality hydraulic motors that allow flow rates of up to 150LPM and then amplified by Auger Torque's own 'bullet-proof' planetary gearbox means that our trenchers have the reliability you need and the power to ensure your trenching is carried out with ease.

### EPICYCLIC GEARBOX

Torque is amplified by using the unique Auger Torque planetary gearbox. This system allows the motors output torque to be multiplied with extreme efficiency as well as ensuring the durability and reliability you need.

### HOSE & ADAPTOR OPTIONS

All Trenchers are supplied as standard with high quality hoses and adaptors.

### MULTIPLE TEETH COMBINATIONS

Chains are available in a number of different teeth configurations for trenching in soft ground, mixed grounds and even permafrost, allowing you to get the job done quickly.

### ADJUSTABLE DEPTH SKID

A great feature that will make your job much easier is the precision depth control skid, which enables the operator to set the machine at up to three different trench depths.

### RAPID CHAIN ADJUSTMENT

Utilising a simple grease point and grease gun, chain adjustment is quicker than ever.



## The days of your trenching bucket may well be over.

The laborious task of digging a trench has been transformed since the advent of the Trencher Attachment.

Suitable for Loaders and Excavators, Auger Torque's range of Trenchers cover depths from 0.6 to 1.5 meters and widths up to 350mm. The spoil is piled neatly to the side of the trench by the integral auger.

Experience how Trencher Attachments can make light work of your construction project.

### Multiple applications including:-

- Ground Heat Pump Systems
- Drainage & Irrigation
- Gas / Water Piping
- Electric Cable
- Fibre Optic Cable
- Larger Bore Gas / Water Piping
- Hedge & Tree Planting



**WATCH  
VIDEO**

# MT Trencher Range



## EXCAVATORS 2.5 - 4.5 T & SKIDSTEER LOADERS

For Trenches  
300-600mm Depth

Oil Pressure Range: 160-240 Bar  
Oil Flow Range: 35-65 lpm  
Unit Width: 850mm  
Unit Height: 736mm  
Unit Length: 1465mm  
Cutting Width Range: 100-300mm

Technical data may be subject  
to change without notice.

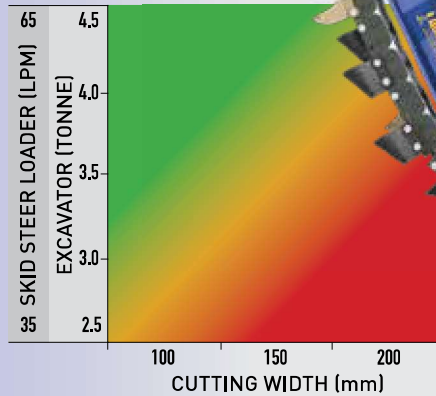
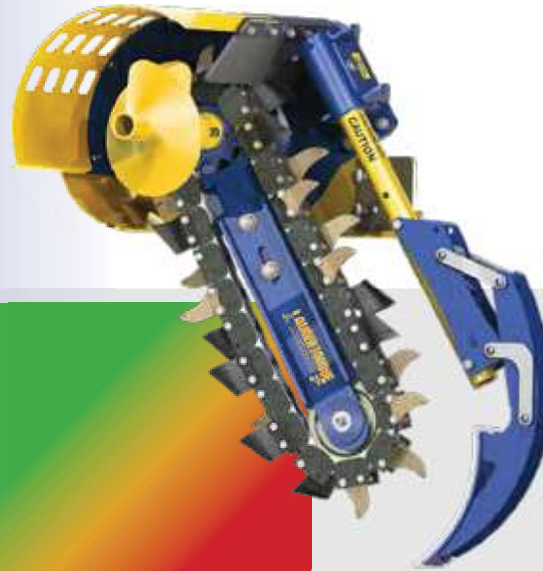

## EXCAVATORS 3 - 5 T & SKIDSTEER LOADERS

For Trenches  
600-900mm Depth

Oil Pressure Range: 180-240 Bar  
Oil Flow Range: 45-80 lpm  
Unit Width: 850mm  
Unit Height: 736mm  
Unit Length: 1800mm  
Cutting Width Range: 100-300mm

Technical data may be subject  
to change without notice.

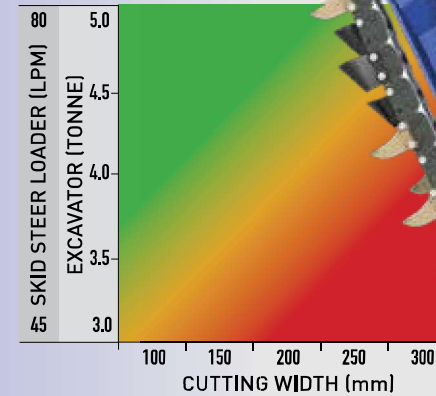
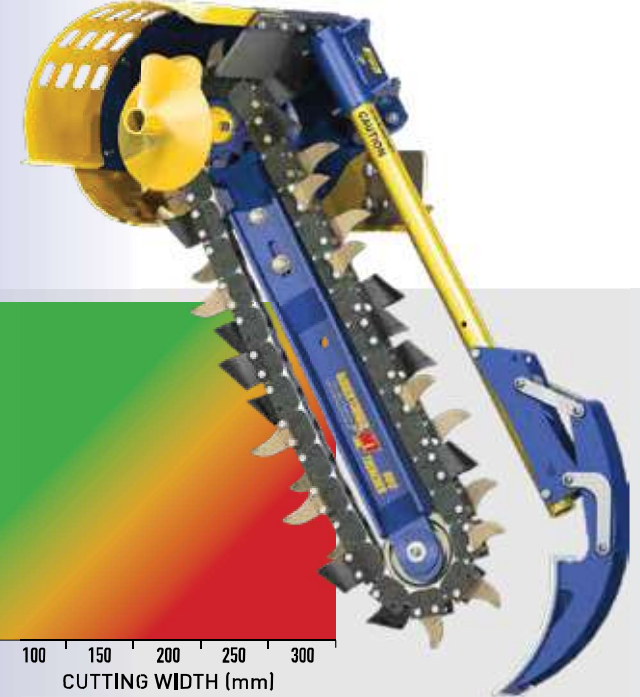

■ IDEALLY SUITED ■ SUITABLE ■ NOT SUITED

### EARTH WEAR PARTS



### TUNGSTEN WEAR PARTS



### BOOM SPARE PARTS





## TRENCH DEPTH CAPABILITY

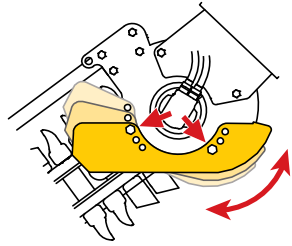

Adjustable Depth-control Skid allows for 3 different depth settings

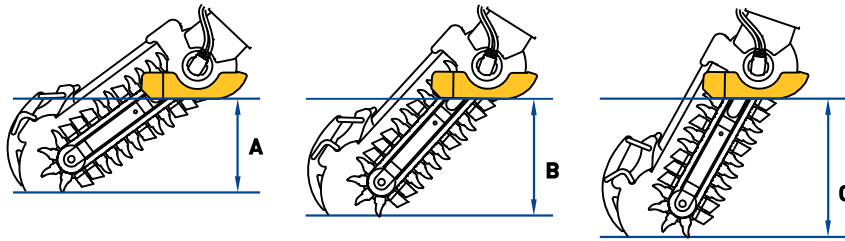

	DEPTH A	DEPTH B	DEPTH C
MT 600	300mm	450mm	600mm
MT 900	600mm	750mm	900mm

## MOUNTING HITCH OPTIONS

Three versions of mounting hitches are available;

### SIDE SHIFT FRAME

For Skidsteer Loaders

### MINI LOADER FRAME

for Mini Loaders

### EXCAVATOR HITCH

Available in several pin sizes to fit most machines.

### Pin diameter options

30mm:	15-53000
35mm	15-53500
40mm	15-54000
45mm	15-54500

## GROUND CONDITIONS

### EARTH

Best suited to soft grounds like earth and clay.

### COMBINATION

Best used in dry, hard or medium ground conditions.

### TUNGSTEN

Best used in dry, hard ground conditions.

## CHAIN OPTIONS

There are a choice of 3 chain options for each machine to allow for differing ground conditions. Check the chain widths available against Auger Torque charts, price lists and specifications.



EARTH  
Soft Ground



COMBINATION  
Mixed Terrain



TUNGSTEN  
Hard Ground /  
Frozen

## CHAIN WIDTH OPTIONS

	100mm	150mm	200mm	250mm	300mm
MT 600 Earth	44-2901	44-2903	44-2905	44-2940	44-2936
MT 600 Combination	44-2902	44-2904	44-2906	44-2919	44-2937
MT 600 Tungsten	44-2918	44-2913	44-2914	44-2945	44-2938
MT 900 Earth	44-2907	44-2909	44-2911	44-2939	44-2933
MT 900 Combination	44-2908	44-2910	44-2912	44-2915	44-2934
MT 900 Tungsten	44-2916	44-2920	44-2921	44-2941	44-2935

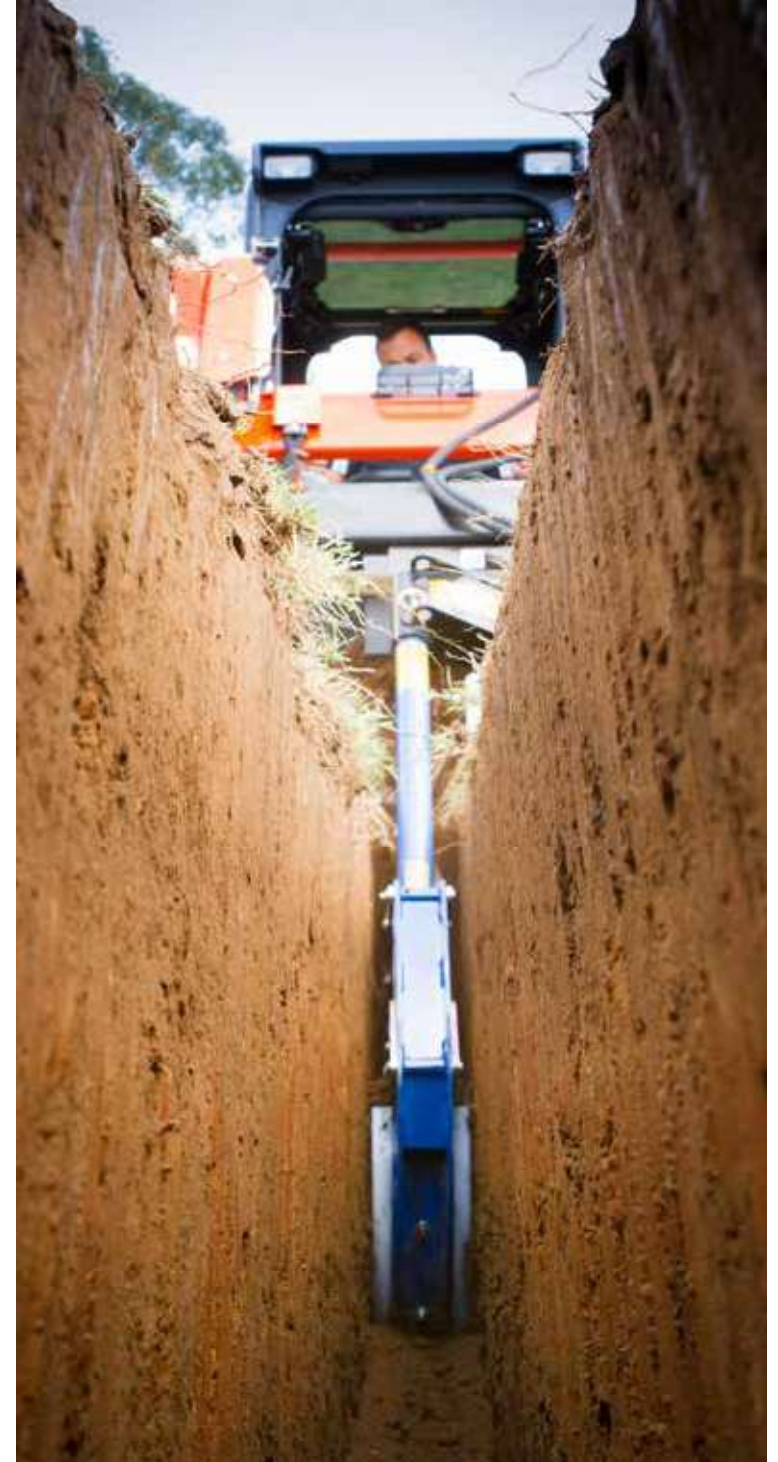

# XHD Trencher Range



## EXCAVATORS 5 - 10 T & SKIDSTEER LOADERS

For Trenches  
600-900mm Depth

Oil Pressure Range: 180-240 Bar  
Oil Flow Range: 60-95 lpm  
Unit Width: 1018mm  
Unit Height: 808mm  
Unit Length: 1962mm  
Cutting Width Range: 150-350mm

Technical data may be subject to change without notice.

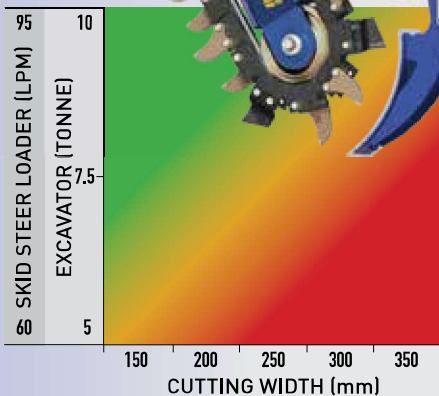
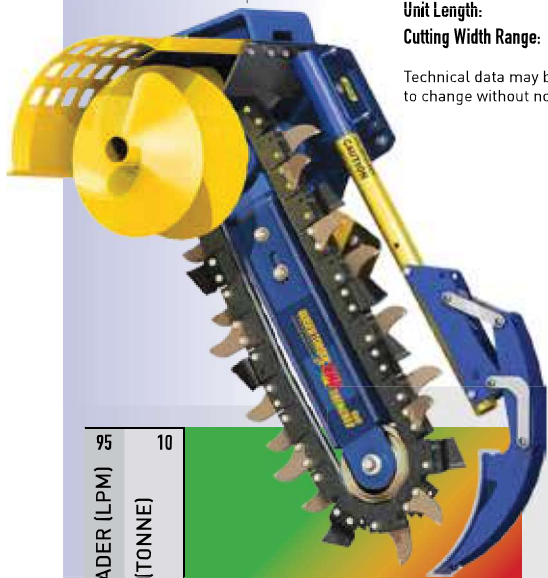

## EXCAVATORS 5 - 10 T & SKIDSTEER LOADERS

For Trenches  
800-1200mm Depth

Oil Pressure Range: 180-240 Bar  
Oil Flow Range: 70-110 lpm  
Unit Width: 1018mm  
Unit Height: 808mm  
Unit Length: 2262mm  
Cutting Width Range: 150-300mm

Technical data may be subject to change without notice.

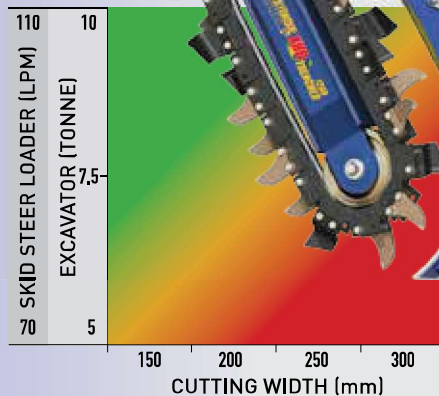
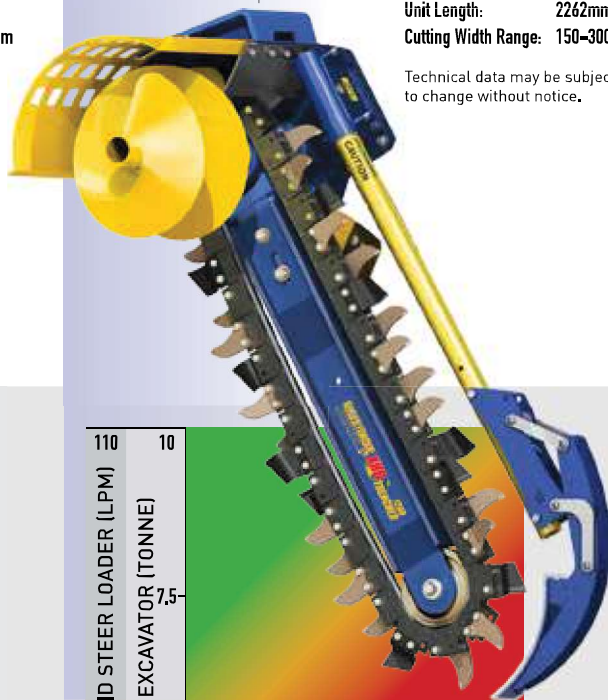

## EXCAVATORS 5 - 10 T & SKIDSTEER LOADERS

For Trenches  
1000-1500mm Depth

Pressure: 180-240 Bar  
Oil Flow Range: 80-115 lpm  
Unit Width: 1018mm  
Unit Height: 808mm  
Unit Length: 2562mm  
Cutting Width Range: 150-200mm

Technical data may be subject to change without notice.

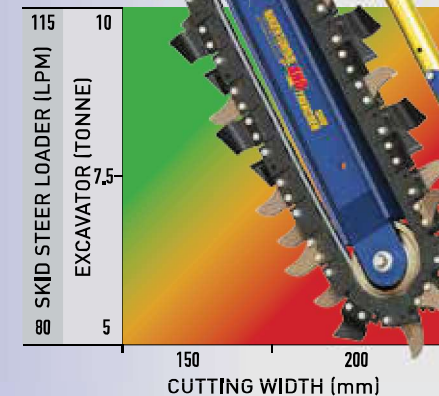
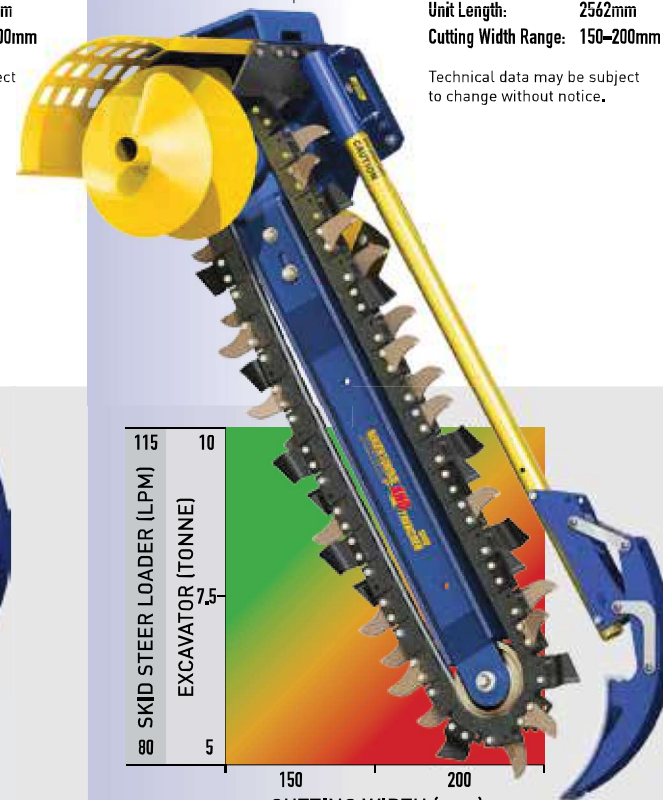

■ IDEALLY SUITED ■ SUITABLE ■ NOT SUITED

### EARTH WEAR PARTS



Earth Tooth  
Left Hand  
44-3001

Earth Tooth  
Right Hand  
44-3002

### TUNGSTEN WEAR PARTS



Tungsten Tooth  
Left Hand  
44-3003

Tungsten Tooth  
Centre  
44-3004

Tungsten Tooth  
Right Hand  
44-3005

### BOOM SPARE PARTS



XHD Sprocket  
43-1019

Nose Roller,  
Bearing &  
Circlip Kit  
43-1900-KIT



## TRENCH DEPTH CAPABILITY

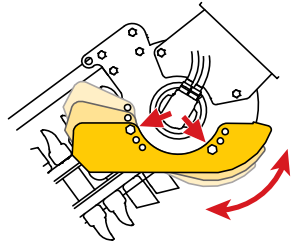

Adjustable Depth-control Skid allows for 3 different depth settings

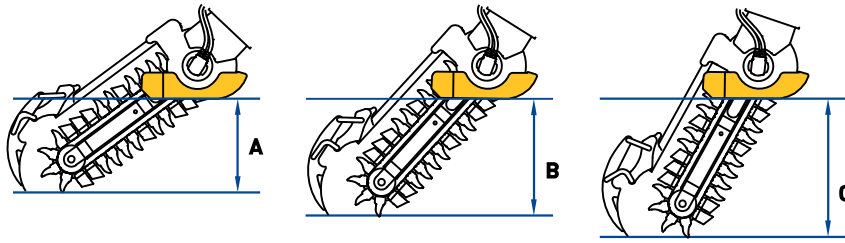

	DEPTH A	DEPTH B	DEPTH C
XHD 900	600mm	750mm	900mm
XHD 1200	800mm	1000mm	1200mm
XHD 1500	1000mm	1250mm	1500mm

## MOUNTING HITCH OPTIONS

Three versions of mounting hitches are available;

### SIDE SHIFT FRAME

For Skidsteer Loaders

### MINI LOADER FRAME

for Mini Loaders

### EXCAVATOR HITCH

Available in several pin sizes to fit most machines.

### Pin diameter options

40mm	15-64000
45mm	15-64500
50mm	15-65000
55mm	15-65500
60mm	15-66000
65mm	15-66500

## GROUND CONDITIONS

### EARTH

Best suited to soft grounds like earth and clay.

### COMBINATION

Best used in dry, hard or medium ground conditions.

### TUNGSTEN

Best used in dry, hard ground conditions.

## CHAIN OPTIONS

There are a choice of 3 chain options for each machine to allow for differing ground conditions. Check the chain widths available against Auger Torque charts, price lists and specifications.



EARTH  
Soft Ground

COMBINATION  
Mixed Terrain

TUNGSTEN  
Hard Ground /  
Frozen

## CHAIN WIDTH OPTIONS

	150mm	200mm	250mm	300mm	350mm
XHD 900 Earth	44-3904	44-3907	44-3910	44-3913	44-3916
XHD 900 Combination	44-3905	44-3908	44-3911	44-3914	44-3917
XHD 900 Tungsten	44-3906	44-3909	44-3912	44-3915	44-3918
XHD 1200 Earth	44-3922	44-3925	44-3928	44-3931	-
XHD 1200 Combination	44-3923	44-3926	44-3929	44-3932	-
XHD 1200 Tungsten	44-3924	44-3927	44-3930	44-3933	-
XHD 1500 Earth	44-3937	44-3940	-	-	-
XHD 1500 Combination	44-3938	44-3941	-	-	-
XHD 1500 Tungsten	44-3939	44-3942	-	-	-

